



Changer

CDC A01

Operating and Installation Instructions

 **BLAUPUNKT**



General Info	2
Safety Instructions	3
Tips for Safe Operation	3
Condensation	3
Before Installing the Equipment	4
Transport Locking Screws	4
Precautions for Installation and Wiring	4
Position of the Built-in Anti-Vibration Armature	5
Using the Changer	6
Loading a CD	6
Installing the Magazine	7
Handling CDs	8
New CDs	8
Parts Used in Installation	9
Wiring	10
Reset Function	10
Installation	11
Installation Procedure for Installation on Carpet (Horizontal Position)	11
Installation Procedure for Installation on Carpet (Vertical Position)	12
Installation Procedure for Installation on Carpet (at a 45° Angle)	14
Installation Procedure (Suspended Installation)	15

Thank you for choosing this Blaupunkt product. We hope that you will enjoy it for a long time to come.

Please read these Operating Instructions before using the product for the first time.

Our editors constantly strive to make our Operating Instructions clear and easy-to-understand. If you still have questions about how to use or install this product, please contact your dealer or call the telephone hotline for your country. The hotline number is listed on the inside back cover of this booklet.

We grant a manufacturer's guarantee on all of our products purchased within the European Union. You can read the terms and conditions of guarantee on the Internet at www.blaupunkt.de or request them directly by writing to:

Blaupunkt GmbH
 Hotline CM/PSS 6
 Robert Bosch Str. 200
 D-31139 Hildesheim, Germany

Safety Instructions

When carrying out installation work and making connections please observe the following safety instructions:

- Electronic vehicle systems may fail if they are incorrectly installed or serviced.
- Disconnect the negative terminal of the battery! When doing so, please observe the vehicle manufacturer's safety instructions.
- Make sure you do not damage vehicle components when drilling any holes.
- Depending on the model, your vehicle may differ from the description provided here. We accept no responsibility for any damages due to incorrect installation or connection or for any consequential damages.

If the information provided here is not suitable for your specific installation requirements, please contact your Blaupunkt dealer, your vehicle manufacturer or our telephone hotline.

Tips for Safe Operation

- This CD changer is designed only for operation in negatively grounded, +12 V DC systems. This device cannot be used in +24 V or positively grounded systems.
- This equipment may not function properly at extremely high or low temperatures. This device is equipped with a built-in automatic protection circuit. If the temperature reaches a pre-set value, the automatic protection circuit will shut down the entire device. If this happens, open a window and let the car cool down.

Condensation

On rainy, damp days or just after turning on the car heater, water vapour may condense on the laser lens of the CD changer. If this happens, the equipment will not function properly. To counteract this, remove the magazine from the device and wait for approximately one hour. During this time, the water vapour will evaporate, after which the equipment will function normally again.

Remove the magazine from the CD changer at temperatures above 60° C if it is not in use, or before long periods of disuse at any temperature.

BEFORE INSTALLING THE EQUIPMENT

Before Installing the Equipment

Transport Locking Screws

The mechanism in the CD changer is "locked" by the transport screws during shipping. Make certain to remove these screws before installing the changer.

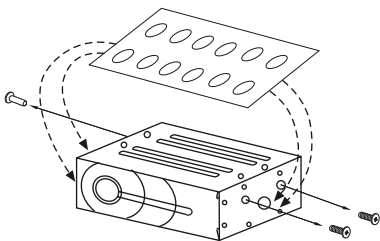

Note:

After removing the transport locking screws, place the enclosed seals over the screw holes. These seals prevent dust from entering the device, which could lead to malfunctions.

Precautions for Installation and Wiring

1. Do not install the equipment in the following locations:
 - Locations that are exposed to direct sunlight.
 - Locations at which warm air exits the car heating system.
 - Locations in which proper installation is impossible and locations in which many vibrations are produced.

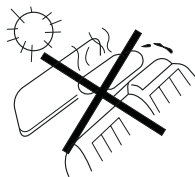

2. - Make certain to use the brackets and screws supplied.
 - When installing the equipment, do not use any screws that are part of the braking or steering systems.
3. The device may only be installed in the approved manner (on one of its sides, on one of its ends, at an angle of 45°, or suspended. If it is installed upside-down or with the front facing down, malfunctions may occur.

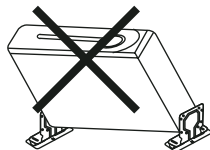
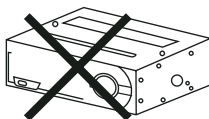
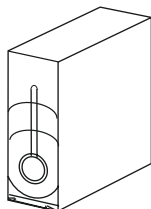
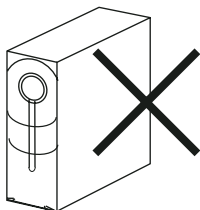

Position of the Built-in Anti-Vibration Armature

This device can be installed horizontally (suspended), vertically, or at a 45° angle. Once you have chosen an installation procedure, you have to set the position of the built-in anti-vibration armature accordingly. Please do this before carrying out the procedures explained below. Vibration may cause CDs to skip if the equipment is used before the anti-vibration system has been configured correctly.

- The anti-vibration armature is set to "0" (for horizontal installation) at the factory before shipping.
- The built-in anti-vibration armature adjusts on both the left and right sides.
- Before attaching the brackets, use a screwdriver to set the position of the anti-vibration armature.

For horizontal or suspended installation:

Make certain that the built-in anti-vibration armature is set to the "0" position.

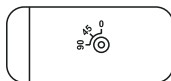

BEFORE INSTALLING THE EQUIPMENT

USING THE CHANGER

For vertical installation:

The built-in anti-vibration armature should be set to the "90" position.

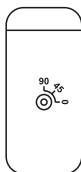

For installation at a 45° angle:

The built-in anti-vibration armature should be set to the "45" position.

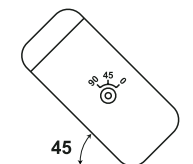

Using the Changer

Loading a CD

1. Press the button on the CD drawer of the magazine and slide out only one drawer.

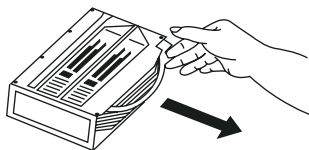

2. Insert the CD in the drawer with the playable side down (in other words, with the label facing up). Each drawer can only hold one CD.

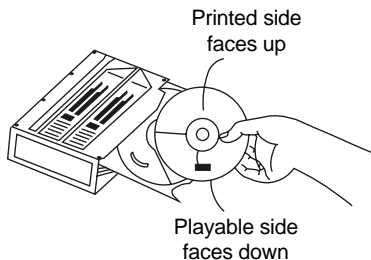

3. Press the button on the CD drawer so that it closes by sliding inside the magazine.

You can load up to ten CDs.

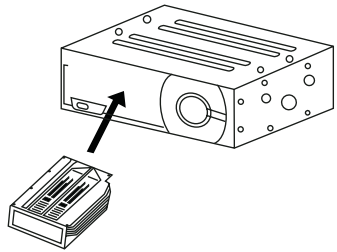
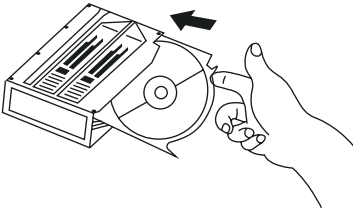

Installing the Magazine

1. Slide the cover to the right.

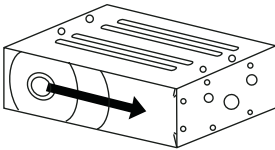

2. First make certain that the magazine is oriented so that the CD labels face up and so that the magazine faces in the proper direction for installation. Insert the magazine until it engages and thus is locked. When the magazine is used for the very first time, it will not engage until the changer is connected to electrical power.

To eject the magazine:

To eject the magazine, press the Eject button (⏏).

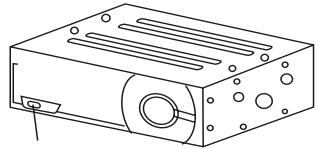

Eject button

Note:

Always close the cover after loading a CD or removing the magazine.

In order to prevent equipment malfunctions, always close the cover. That way the equipment is impervious to dust, dirt, and other foreign bodies.

Handling CDs

New CDs

The following symptoms often occur when using new CDs:

- The CD does not play evenly after being inserted.
- The changer changes to the next CD before it has finished playing the first CD.
- The changer plays the same CD over and over again.
- The system will not play a specific CD.

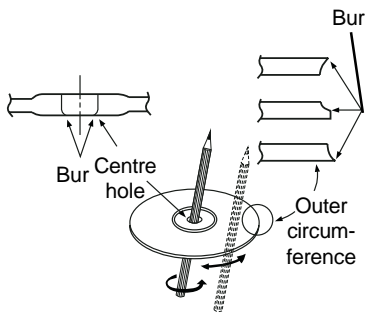

Remove from the CD surface all plastic particles from burs before inserting the CD in the magazine.

These symptoms occur when there are burs on the CD in the centre hole or along the outer circumference of the CD and, as a result, the CD is not drawn into the changer properly or sticks somewhat inside the magazine. If these

things happen, use a pen or a similar object to remove the burs as shown in the figure at right.

Note:

Although there are protective films marketed as CD accessories, use of these products leads to malfunctions and should be strictly avoided.

Dirt, dust, scratches, and deformations cause skipping and diminished sound quality during playback. Here are some tips on how to take care of your CDs:

1. Use CDs that bear the following symbol.



2. Use a soft cloth to wipe away fingerprints and dust from the playable (shiny) side of the CD. Unlike phonograph records, CDs have no grooves to collect dust and small particles. Thus gentle wiping is usually sufficient to remove most particles. Wipe from the centre of the CD straight outwards. Small dust particles and spots do not affect playback quality.
3. Never use chemicals such as record cleaner, anti-static spray or fluid, benzene or paint thinner to clean your CDs. Use of these chemicals will lead to irreparable damage to the plastic surface of the CD.

4. After use, return the CDs to their protective cases to avoid major scratches that can lead to skipping on playback.
5. Never store CDs where they are exposed to direct sunlight, high humidity, or high temperatures over long periods. CDs may warp if exposed to high temperatures over long periods.
6. The playable side of the CD should not be pasted with paper or marked with a ballpoint pen.

Parts Used in Installation

Bracket (A)

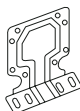

2 x

Bracke (B)

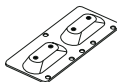

2 x

Hex bolt (M6 x 12)



4 x

Console bolt (M4 x 5)



4 x

Tap screw (M5 x 12)



4 x

PARTS USED IN INSTALLATION

8-pin DIN cable



1 x

Seals

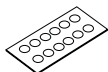

1 x

Double-sided adhesive tape



2 x

Wiring

Connect this cable to the main unit

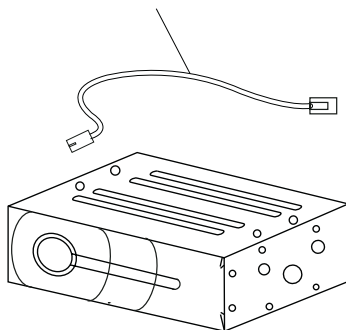

Reset Function

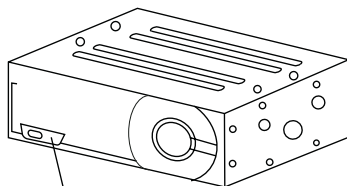

Reset button

You must use a ballpoint pen or a thin piece of metal to press the reset button. It should be pressed in the following situations:

- During initial installation of the unit, after wiring has been completed.
- If some functions do not work.

Installation Procedure for Installation on Carpet (Horizontal Position)

1.

- Make certain that the built-in anti-vibration armature has been set to the "0" position on both the right and left sides.
- Using the hex bolts (M4 x 5), fasten the left and right brackets (A).
- Fasten the left and right brackets (A) to the corresponding brackets (B). Do this using the hex bolts (M6 x 12) and hex nuts (M6).

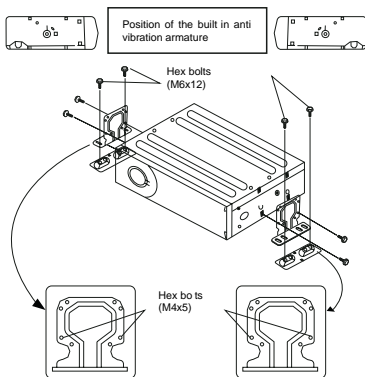

2.

- Lift up the carpet and decide where you want to mount the unit.
- Fasten the double-stick tape supplied to the bottoms of the brackets (B) and remove the protective backing from the tape.
- Fasten the unit to the floor by pressing it down firmly.

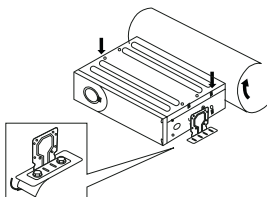

3.

- Unscrew the hex nuts and remove the CD changer.

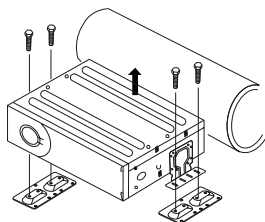

INSTALLATION

4.

- Using a knife, cut through the carpet directly above the bolts of the mounting bracket (B).
- Replace the carpet in its original position, so that the bolts poke through the carpet.

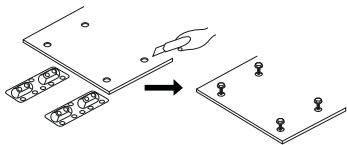

5.

- Using the hex bolts again, refasten the changer on top of the carpet.

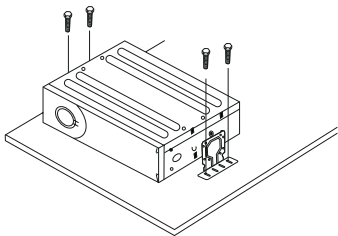

Installation Procedure for Installation on Carpet (Vertical Position)

1.

- Make certain that the built-in anti-vibration armature has been set to the "90°" vertical installation position on both the right and left sides.
- Using the hex bolts (M4 x 5), fasten the left and right brackets (A).
- Fasten the left and right brackets (A) to the corresponding brackets (B). Do this using the hex bolts (M6 x 12) and hex nuts (M6).

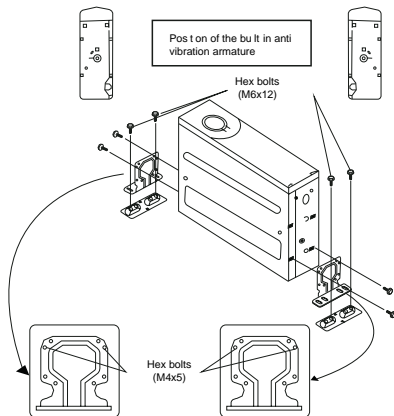

2.

- Lift up the carpet and decide where you want to mount the unit.
- Fasten the double-stick tape supplied to the bottoms of the brackets (B) and remove the protective backing from the tape.
- Fasten the unit to the floor by pressing it down firmly.

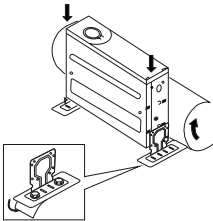

3.

- Unscrew the hex nuts and remove the CD changer.

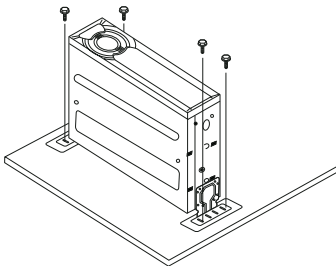

4.

- Using a knife, cut through the carpet directly above the bolts of the mounting bracket (B).
- Replace the carpet in its original position, so that the bolts poke through the carpet.

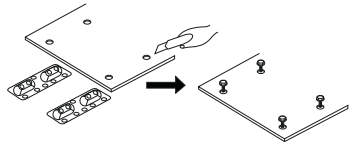

5.

- Using the hex bolts again, refasten the changer on top of the carpet.

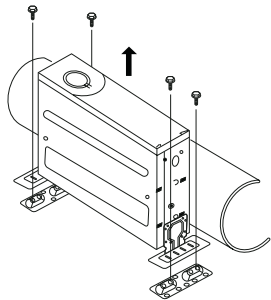

INSTALLATION

Installation Procedure for Installation on Carpet (at a 45° Angle)

1.

- Set the built-in anti-vibration armature to the 45° position "45" on both the right and left sides.
- Using the hex bolts (M4 x 5), fasten the left and right brackets (A).
- Fasten the left and right brackets (A) to the corresponding brackets (B). Do this using the hex bolts (M6 x 12) and the hex nuts (M6).

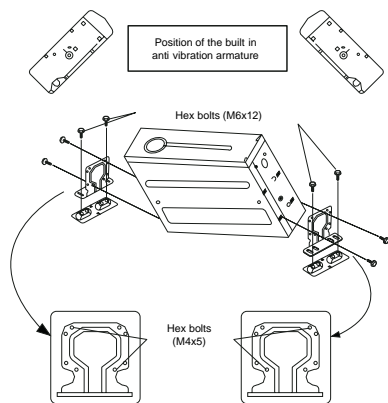

2.

- Lift up the carpet and decide where you want to mount the unit.
- Fasten the double-stick tape supplied to the bottoms of the brackets (B) and remove the protective backing from the tape.
- Fasten the unit to the floor by pressing it down firmly.

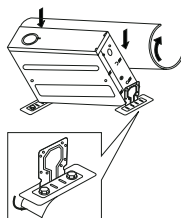

3.

- Unscrew the hex nuts and remove the CD changer.

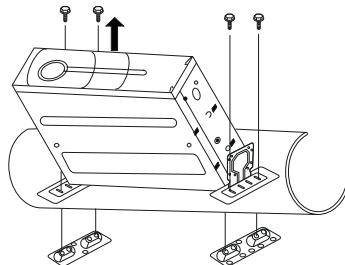

4.

- Using a knife, cut through the carpet directly above the screws of the mounting bracket (B).
- Replace the carpet in its original position, so that the screws poke through the carpet.

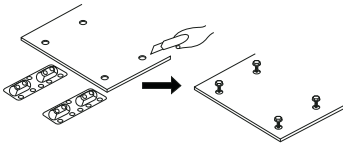

5.

- Using the hex bolts again, refasten the changer on top of the carpet.

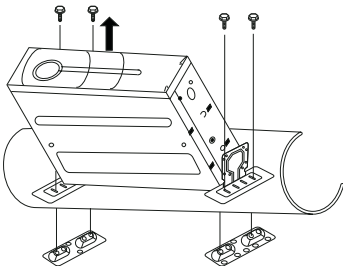

Installation Procedure (Suspended Installation)

1.

- Make certain that the built in anti-vibration armature has been set to the "0" position on both the left and right sides.
- Using the hex bolts (M4 x 5), fasten the left and right brackets (A).

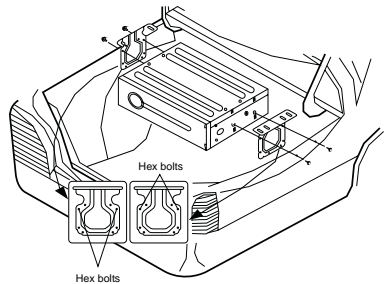
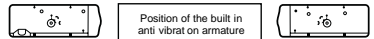

INSTALLATION

2.

- Determine where you want to install the unit and drill four mounting holes.

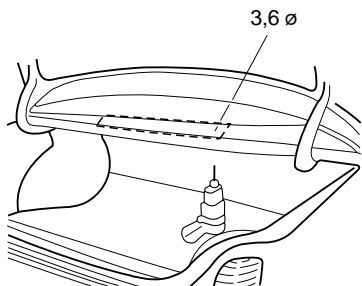

3.

- Fasten the CD changer using the tap screws (M5 x 12).

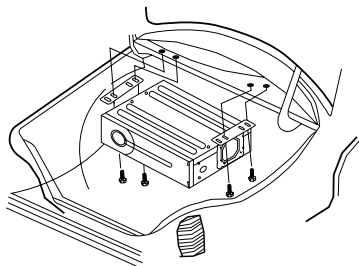

Service numbers / Numéros du service après-vente / Números de servicio / Números de serviço

Country:	Phone:	Fax:	WWW:
Germany	(D) 0180-5000225	05121-49 4002	http://www.blaupunkt.com
Austria	(A) 01-610 390	01-610 393 91	
Belgium	(B) 02-525 5454	02-525 5263	
Denmark	(DK) 44 898 360	44-898 644	
Finland	(FIN) 09-435 991	09-435 99236	
France	(F) 01-4010 7007	01-4010 7320	
Great Britain	(GB) 01-89583 8880	01-89583 8394	
Greece	(GR) 0800-550 6550	01-576 9473	
Ireland	(IRL) 01-4149400	01-4598830	
Italy	(I) 02-369 6331	02-369 6464	
Luxembourg	(L) 40 4078	40 2085	
Netherlands	(NL) 023-565 6348	023-565 6331	
Norway	(N) 66-817 000	66-817 157	
Portugal	(P) 01-2185 00144	01-2185 11111	
Spain	(E) 902-120234	916-467952	
Sweden	(S) 08-7501500	08-7501810	
Switzerland	(CH) 01-8471644	01-8471650	
Czech. Rep.	(CZ) 02-6130 0441	02-6130 0514	
Hungary	(H) 01-333 9575	01-324 8756	
Poland	(PL) 0800-118922	022-8771260	
Turkey	(TR) 0212-3350677	0212-3460040	
USA	(USA) 800-2662528	708-6817188	
Brasil (Mercosur)	(BR) +55-19 3745 2769	+55-19 3745 2773	
Malaysia (Asia Pacific)	(MAL) +604-6382 474	+604-6413 640	

Blaupunkt GmbH

